

Networking Guide

Notice

The material and instructions covered in this manual have been carefully checked for accuracy and are presumed to be reliable. However, the manufacturer assumes no responsibility for inaccuracies and reserves the right to modify and revise this document without notice.

These instructions are for connecting, programming, and operating D9024 and D10024 Fire Alarm Control Panels in a network controlled by a D9024 or D10024 master panel. See the D9024 and D10024 Installation, Operation, and Programming Instructions for specific information on individual D9024 and D10024 Fire Alarm Control Panel Systems.

Warnings and Cautions

Warning: is used in these instructions to indicate procedures to follow to avoid injury.

Caution: is used in these instructions to indicate procedures to follow to avoid damage to equipment.

FCC Notices

Part 15

This equipment has been tested and found to comply with the limits for a Class A digital device, pursuant to Part 15 of the FCC Rules. These limits are designed to provide reasonable protection against harmful interference in a commercial installation. This equipment generates, uses and can radiate radio frequency energy, and, if not installed in accordance with the instructions, may cause harmful interference to radio communications. However, there is no guarantee that interference will not occur in a particular installation. If this equipment does cause harmful interference to radio or television reception, which can be determined by turning the equipment on and off, the user is encouraged to try to correct the interference by one or more of the following measures:

- 1) Reorient or relocate the receiving antenna
- 2) Increase the separation between the equipment and the receiver
- 3) Connect the equipment into an outlet on a circuit different from that to which the receiver is connected.
- 4) Consult the dealer or an experienced radio/TV technician for help.

UL/NFPA Notices

- UL listed for NFPA 72, Local.

All references to NFPA and related requirements are based upon compliance with the 1993 edition of NFPA 72, National Fire Alarm Code. Since installation specifications are nearly always based upon a specific edition of a standard that has been legally adopted by the Authority Having Jurisdiction (AHJ), earlier editions of NFPA standards will generally apply. Consult with the appropriate AHJ for confirmation.



Tables

Table of Contents

Networking Guide	1
Notice	1
Warnings and Cautions	1
FCC Notices	1
UL/NFPA Notices	1
A. Network Installation	4
A.1. Serial Port Assignment and Function	4
A.2. Single System Installations	4
B. Shared Zone Network	4
B.1. Shared Zone Network Operation	5
B.2. Shared Zone Network Programming	6
B.2.a. Master Panel Programming, Shared Zone Network	6
B.2.b. Slave Panel Programming, Shared Zone Network	8
C. Report and Control Network	11
C.1. Report and Control Network Operation	11
C.2. Report and Control Network Programming	12
C.2.a. Master Panel Programming, Report & Control Network	12
C.2.b. Slave Panel Programming, Report & Control Network	15
D. Panel Programming Options	18

Table of Figures

Figure 1: D9051 Network Connections	4
Figure 2: Shared Zone Network	5
Figure 3: Control Keys	6
Figure 4: Main Menu	6
Figure 5: Path Through Commission Menus to Network	6
Figure 6: Network Menu One	7
Figure 7: Network Menu Two	7
Figure 8: Network Menu Three	7
Figure 9: Network Menu Four	7
Figure 10: Network Menu Five	7
Figure 11: Network Menu Six	8
Figure 12: Network Menu Seven	8
Figure 13: Network Menu Eight	8
Figure 14: Commission Menu Three	8
Figure 15: Master-to-Slave Menu One	8
Figure 16: Commission Menu One	8
Figure 17: Commission Menu Three	9
Figure 18: Network Menu One	9
Figure 19: Network Menu Two	9
Figure 20: Network Menu Four	9
Figure 21: Network Menu Five	9
Figure 22: Network Menu Six	10
Figure 23: Network Menu Seven	10
Figure 24: Network Menu Eight	10
Figure 25: Commission Menu Three	10
Figure 26: Configure Menu	10
Figure 27: Memory Check Message	10
Figure 28: Commission Menu Three	10
Figure 29: Master Panel Fault Condition Display	11



Table of Figures

Table of Figures, Continued

Figure 30: RS 485 Link Message	12
Figure 31: Master Panel Event Log Display	12
Figure 32: Main Menu	13
Figure 33: Path Through Commission Menus to Network	13
Figure 34: Network Menu One.....	13
Figure 35: Network Menu Two.....	13
Figure 36: Network Menu Three	14
Figure 37: Network Menu Four	14
Figure 38: Network Menu Five	14
Figure 39: Network Menu Six	14
Figure 40: Remote Alarms Query Menu	14
Figure 41: Network Menu Seven	14
Figure 42: Network Menu Eight	15
Figure 43: Commission Menu Three.....	15
Figure 44: Master-to-Slave Menu One.....	15
Figure 45: Commission Menu One	15
Figure 46: Commission Menu Three.....	15
Figure 47: Network Menu One.....	16
Figure 48: Network Menu Two.....	16
Figure 49: Network Menu Four	16
Figure 50: Network Menu Five	16
Figure 51: Network Menu Six	16
Figure 52: Remote Alarms Query Menu	16
Figure 53: Network Menu Seven	17
Figure 54: Network Menu Eight	17
Figure 55: Commission Menu Three.....	17
Figure 56: Configure Menu	17
Figure 57: Memory Check Message	17
Figure 58: Commission Menu Three.....	17

Table of Tables

Table 1: Shared Zone Configuration	5
--	---

A. Network Installation

All panels must be D9024 or D10024 Fire Alarm Control Panels. The network wiring is supervised. A fault in the network wiring results in a warning message. In a fault condition on the network wiring each panel will operate as a stand-alone unit.

Note: In a shared zone network, notification appliance peripherals associated with a specific zone can be attached to any panel on the system.

Warning: Notification appliances connected to one panel that are associated with detection devices on other panels will not activate in a network wiring fault condition.

A.1. Serial Port Assignment and Function

Serial network data communications take place using D9051 RS 485 Bus Modules attached to Serial Port C on the Panel Control Module.

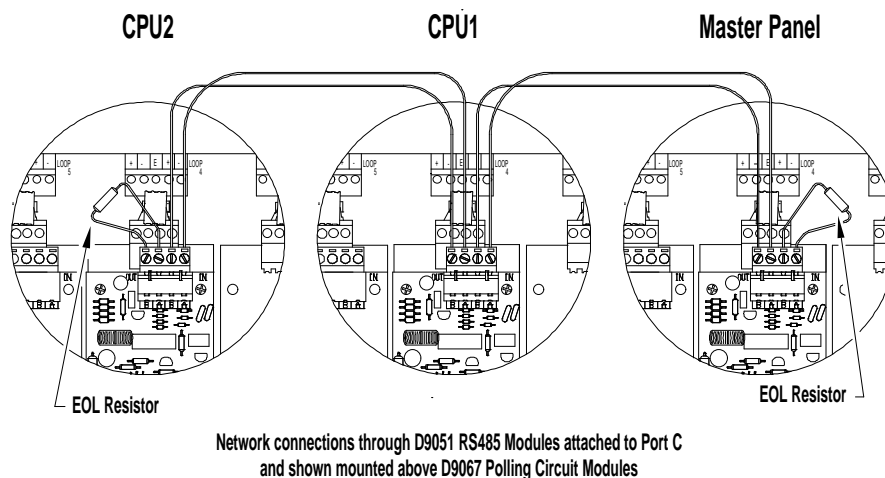

Figure 1: D9051 Network Connections

A.2. System Installations

The panels are wired in series to an NFPA Class B, Style 3.5 signaling line circuit on the appropriate RS 485 bus. The RS 485 terminals on the D9051 Module are polarity sensitive. The channels are marked A and B, and data cables should be connected A to A and B to B. Cross-wiring between channels will result in corrupted data but will not damage equipment.

Use shielded twisted pair wiring such as the Data Grade Cable D293, Beldon 8670 two-core twisted pair, or non-shielded 18 gauge cable from Atlas, Guardian Sound & Security, or their equals. To avoid data corruption, route cables so that they do not run next to other cables.

The total length of the data cables between the two end panels must not exceed 3,935 ft. per channel.

B. Shared Zone Network

This system is usually an installation in a single site or building. Multiple panels are networked together using common zones. This configuration can have up to 99 zones with 2,520 addressable points. See Table 1.

In the Shared Zone Network up to four D9024 and/or D10024 panels are networked together with one panel designated to act as the Master.

Table 1: Shared Zone Configuration

Panel	Number of Zones	Max. No. Addressable Points	Max. No. Outputs Notification Appliances / Relays
D9024	40	1,512	400
D10024	40 expandable to 99	2,520	400

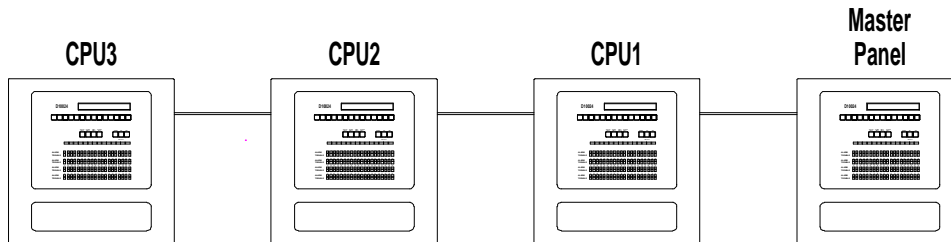

Figure 2: Shared Zone Network

These systems share common zones (max. 40, 80, or 99, dependent on the panel types) and act as one large system.

B.1. Shared Zone Network Operation

Alarm Conditions:

- The location text message of the first alarm on the system will be displayed on the LCD of the master panel and all of the sub panels on the network.
- The location text message from subsequent alarms will appear only on the master panel and on the panel of origin. The local message will override any global message on the panel of origin.
- All sub panels will automatically scroll through the first four local alarm text messages.
- The Master panel will automatically scroll through the first four global alarm text messages, regardless of origin.
- The zonal fire LED indications on all panels will illuminate to show all zones in alarm on the total system.

The outputs and notification appliances will follow the programmed zonal settings. (All outputs from any panel that are programmed to a particular zone will perform as programmed when a fire is detected in that zone, regardless of which panel detects the fire.)

Note: The maximum number of outputs (notification appliances/relays) is 100 per panel.

Note: In a shared zone network, notification appliances associated with a specific zone can be attached to any panel on the system.

Warning: Notification appliances connected to one panel that are associated with detection devices in alarm on other panels will not activate in a network wiring fault condition.

In a fault condition:

- Alarm text messages override fault text messages.
- The master panel scrolls through the first four network faults.
- The master panel LEDs indicate all fault conditions on the network.
- Local panels scroll through the first four local faults
- Local panel LEDs indicate all zones in fault condition on that panel.

The operator may use the control keys on any panel to respond to alarm and fault conditions.

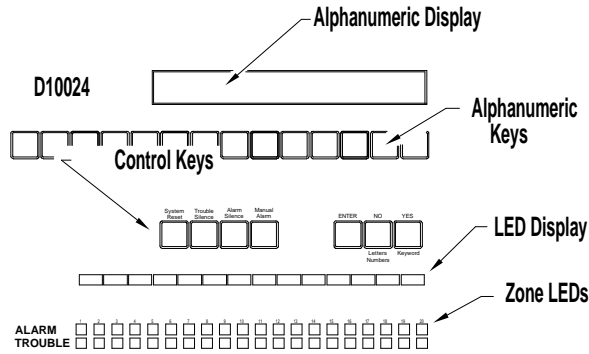

Figure 3: Control Keys

Repeaters and peripherals:

- Repeater panels will mimic the text information on the LCD of the panel to which they are connected.

B.2. Shared Zone Network Programming

Follow the instructions in the D9024/D10024 Programmer's Guide, Radionics part number 74-07662-000, to set up and configure individual panels. To simplify the network programming procedure, the panels may be set up so that all programming is done from the master panel. To do this, run the setup sequence, Section C.1. of the D9024/D10024 Programmer's Guide, on each panel and set the Memory Lock Check, Section C.1.h., to [No]. Leave the memory lock switch in the unlocked position. After completing the Master Panel Network Programming use the procedure outlined at the beginning of Section B.2.b. of this guide to program the slave panels.

B.2.a. Master Panel Programming, Shared Zone Network

Press the ">" key to display the Operator's Menu, Main Level.

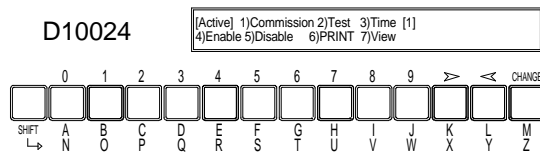

Figure 4: Main Menu

Select option one 1) Commission, by pressing the "1" key.
The display prompts, "Please key in your password"

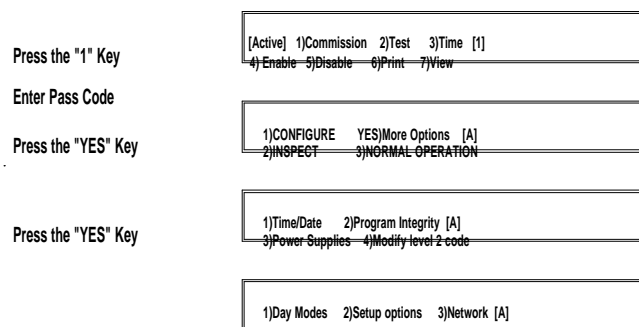

Figure 5: Path Through Commission Menus to Network

Enter the Level Three Pass Code (9898).

The display shows the first of the three Commission Menus.

Press YES twice to page to Commission Menu Three.

Press 3 to enter Network options.

Unlock the memory using the Memory Lock Switch. The memory must be locked at the end of the programming session. The panel will not allow a reset unless the memory is locked.

Press 3. The panel displays Network Menu One.

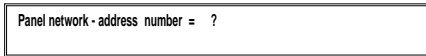

Panel network - address number = ?

Figure 6: Network Menu One

Enter the Network address for the Master Panel. This is a number from one to 20.

Note: In messages on the LCD, the panel software will identify the first slave panel as Slave CPU 1, the second slave panel as Slave CPU 2, and so on.

Avoid confusion between network addresses and panel identifications by giving the master panel a unique identification number (i.e. 10).

The panel displays Network Menu Two.

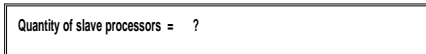

Quantity of slave processors = ?

Figure 7: Network Menu Two

Enter the number of slave processors (1 to 3 in a shared zone network). The panel displays Network Menu Three

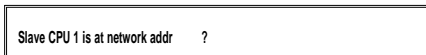

Slave CPU 1 is at network addr ?

Figure 8: Network Menu Three

Enter the address for the first slave CPU. Network Menu Three will change to prompt for the address of the next slave CPU until the number of slave processors entered in Network Menu Two are identified.

The panel then displays Network Menu Four.



Use modem [FALSE] ?

Figure 9: Network Menu Four

Enter YES if the master panel is NOT connected to a modem. If a modem is connected to Port B or Port C of the master panel, press CHANGE to alter the statement to TRUE and press ENTER.

The panel displays Network Menu Five.



Share zones [TRUE] ?

Figure 10: Network Menu Five

Press YES.

The panel displays Network Menu Six.





Peer to Peer [TRUE] ?

Figure 11: Network Menu Six

If necessary, use the CHANGE Key to set Peer to Peer to [True] and press YES.
The panel displays Network Menu Seven.

Port B Protocol = 0 ? (Normal = 0)

Figure 12: Network Menu Seven

Press YES.
The panel displays Network Menu Eight.

System events [GLOBAL] ?

Figure 13: Network Menu Eight

Press YES.
The panel displays Commission Menu Three.

1)Day Modes 2)Setup options 3)Network [10]

Figure 14: Commission Menu Three

B.2.b. Slave Panel Programming, Shared Zone Network

Program the each of the slave panels using option 3)Network on the Commission Menu Three. If the Master Panel and the slave CPU(s) are set up as outlined in section B.2. with the memory lock switch left in the unlocked position, all programming may be done from the Master Panel. This section outlines that procedure.

Note: After completing slave Panel Programming, run the setup program at each panel, set memory lock check to YES, and lock the memory.

The slave CPU(s) may be programmed individually using the control keys on each panel to access Commission Menu Three.

Select Option 4)Talk to Slave from Commission Menu Three.

The Panel queries for the CPU number.

CPU_

Figure 15: Master-to-Slave Menu One

Note: In messages on the LCD, the panel software will identify the first slave panel as Slave CPU 1, the second slave panel as Slave CPU 2, and so on.

Enter 01 to talk to CPU1.

The panel displays Commission Menu One.

[Active] 1)Commission 2)Test 3)Time [1]
4)Enable 5)Disable 6)Print 7)View

Figure 16: Commission Menu One

Note: CPU1 is now being programmed from the Master Panel. The menu displayed on the Master Panel is Commission Menu One of Slave Panel One (CPU1). The display on both panel displays is identical and programming may be performed from either or both panels.

Select option 1)Commission.

The panel prompts for the password.

Enter the Level Three Pass Code (9898).

Press YES twice to reach Commission Menu Three (on CPU1).

The panel displays Commission Menu Three.

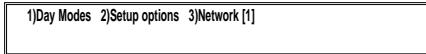

Figure 17: Commission Menu Three

Select option 3)Network.

The Panel displays Network Menu One.

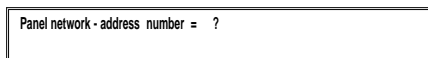

Figure 18: Network Menu One

Enter the Network address for CPU1. This is a number from one to 20.

Note: In messages on the LCD, the panel software will identify the first slave panel as Slave CPU 1, the second slave panel as Slave CPU 2, and so on.

Avoid confusion by giving each slave panel the same identifier as the panel software: e.g. assign CPU1 the network address one (1).

Enter a number and press ENTER.

The panel displays Network Menu Two.

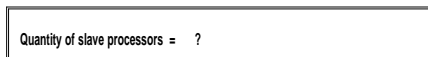

Figure 19: Network Menu Two

Enter zero and press Enter. The panel displays Network Menu Four.



Figure 20: Network Menu Four

Enter YES if CPU1 is NOT connected to a modem. If a modem is connected to Port B or Port C of CPU1, press CHANGE to alter the statement to TRUE and press ENTER.

The panel displays Network Menu Five.



Figure 21: Network Menu Five

Press YES.

The panel displays Network Menu Six.





Figure 22: Network Menu Six

If necessary, use the CHANGE Key to set Peer to Peer to [True] and press YES. The panel displays Network Menu Seven.

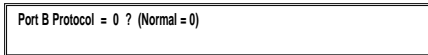

Figure 23: Network Menu Seven

The Port B Protocol for the slave panels in a shared zone network must be set to 0. Press YES.

The panel displays Network Menu Eight.



Figure 24: Network Menu Eight

Press YES.

The panel displays Commission Menu Three.



Figure 25: Commission Menu Three

Press NO to return to the Configure Menu.

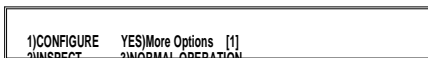

Figure 26: Configure Menu

Enter 3)NORMAL OPERATION.

The display shows the Memory Check Message.

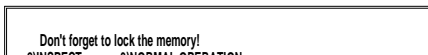

Figure 27: Memory Check Message

If the Master Panel and the slave CPU(s) are set up as outlined in section B.2 press 3)Normal Operation a second time to return to Commission Menu One. Press RESET. This closes the Network process for CPU1 and returns the display returns to Commission Menu Three for the Master Panel.

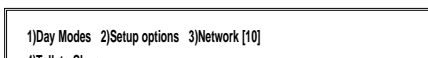

Figure 28: Commission Menu Three

Repeat the network programming procedure (beginning at Section B.2.b.) for each slave panel. After completing network programming for the last slave panel press NO from Commission Menu Three and return to Commission Menu Three for the Master Panel.

Press NO to return to the Configure menu.

Press 3)NORMAL OPERATION to return to the Operator's Menu, Mail Level.

Run the Set Up procedure as described in section C.1. of the Programmer's Guide and set the Memory Lock Check (Section C.1.h.) to [Yes] on the Master Panel and each Slave Panel.

C. Report and Control Network

The Report and Control Network links the individual panels to a master panel for reporting and control. Up to 10 D9024 and/or D10024 panels may be networked together in a Report and Control Network with one dedicated panel designated to act as the Master.

C.1. Report and Control Network Operation

Alarm Conditions:

- The LCDs of the Master Panel and the Panel of Origin display the location text message of the first alarm on the system. Other panels in the network do not acknowledge the alarm condition and continue normal polling.
- The location text message from subsequent alarms appears on the Panel of Origin and the Master Panel.
- The relay outputs and notification appliances connected to the panel of origin will follow programmed zonal settings for their individual units.
- The ALARM SILENCE key on the Panel of Origin or the Master Panel deactivates and reactivates notification appliances. The Panel of Origin key controls notification appliances connected to that panel. The Master Panel key controls all notification appliances in alarm on the network.
- The Master Panel will automatically scroll through the first four alarm text messages, regardless of origin.
- The LED zone indicators on the panel of origin will illuminate to show all zones in alarm on that panel.
- The FIRE DRILL (MANUAL ALARM) key on the Master Panel activates only the notification appliances attached to master panel.

System Reset from Alarm Conditions:

- The SYSTEM RESET key on the Panel of Origin resets that panel. The SYSTEM RESET key on the Master Panel resets all the panels on the network.
- After the condition is cleared, the panel of origin may be reset from the Panel of Origin or from the Master Panel. If the reset is from the panel of origin, the alarm message on the LCD display of the Master Panel and the LED alarm indications on the Master Panel remain until the Master Panel is reset.

Fault Condition:

- Alarm text messages override fault text messages.
- The text display on the Panel of Origin scrolls through the first four fault messages on that panel.
- The text display on the Master Panel scrolls through the first four network fault messages



Figure 29: Master Panel Fault Condition Display

This display on the Master Panel indicates that CPU3 has a fault condition -an open input circuit at address 20 on polling loop one, a manual call point.

- A fault condition results in a System Trouble LED at the panel of origin and at the Master Panel. The Master Panel's System Trouble LED indicates a fault conditions on the network.

- The TROUBLE SILENCE key on the Panel of Origin silences the buzzer at that panel, but not at the Master Panel.
- The TROUBLE SILENCE key at the Master Panel silences Master Panel buzzer. The System Trouble and Trouble Silenced LEDs on all panels in a fault condition remain lit.
- A fault in the RS 485 link results in a panel buzzer at the Master Panel and an LCD display indicating the CPU link that is lost. See Figure 29 below.



```
CPU2 NO REPLY FROM 485/232 LINK
```

Figure 30: RS 485 Link Message

This display indicates that network connection is lost between CPU1 and the rest of the network. The remaining panels continue to operate independently.

- The location text message of the first fault on the system will be displayed on the LCD of the Master and the panel of origin.
- The SYSTEM RESET key on the Master Panel resets all the panels on the network.
- The master panel scrolls through the first four network faults.
- Local panels scroll through the first four local faults
- Local panel LEDs indicate all zones in fault condition on that panel.

Event Log:

- The panel of origin event log performs identically to a stand-alone installation.
- The Master Panel logs network events. The Master Panel event log display indicates the sub panel associated with each event. See Figure 30.

```
Entry 57 13:38 12-Mar [1] 1:020
```

Figure 31: Master Panel Event Log Display

In the display above Entry 57 occurred at 13:38 on March 12th on CPU1. The alarm was in response to a signal from the device at address 20 of polling loop one.

D9070 Controllers and D9069 Annunciators

The displays on these devices mimic the text information on the LCD of the panel to which they are connected.

Note: The maximum number of outputs (notification appliances/relays) is 100 per panel.

C.2. Report and Control Network Programming

Follow the instructions in the D9024/D10024 Programmer's Guide, Radionics part number 74-07662-000, to set up and configure individual panels. To simplify the network programming procedure, the panels may be set up so that all programming is done from the master panel. To do this, run the setup sequence, Section C.1. of the D9024/D10024 Programmer's Guide, on each panel and set the Memory Lock Check, Section C.1.h, to [No]. Leave the memory lock switch in the unlocked position. After completing the Master Panel Network Programming use the procedure outlined at the beginning of Section C.2.b. of this guide to program the slave panels.

C.2.a. Master Panel Programming, Report and Control Network

Press the ">" key to display the Operator's Menu, Main Level.

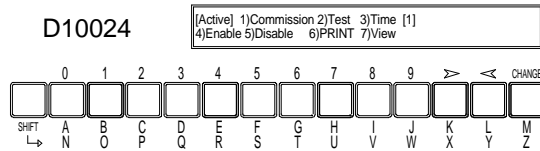

Figure 32: Main Menu

Select option one 1) Commission, by pressing the “1” key.
The display prompts, “Please key in your password”

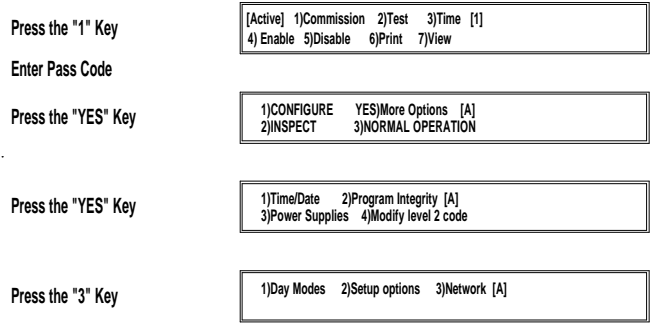

Figure 33: Path Through Commission Menus to Network

Enter the Level Three Pass Code (9898).

The display shows the first of the three Commission Menus.

Press YES twice to page to Commission Menu Three.

Press 3 to enter Network options.

Unlock the memory using the Memory Lock Switch. The memory must be locked at the end of the programming session. The panel will not allow a reset unless the memory is locked.

Press 3. The panel displays Network Menu One.

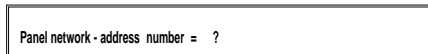

Figure 34: Network Menu One

Enter the Network address for the Master Panel. This is a number from one to 20.

Note: In messages on the LCD, the panel software will identify the first slave panel as Slave CPU 1, the second slave panel as Slave CPU 2, and so on.

Avoid confusion between network addresses and panel identifications by giving the master panel a unique identification number (i.e. 10).

The panel displays Network Menu Two.

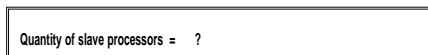

Figure 35: Network Menu Two

Enter the number of slave processors (1 to 9 in a report and control network). The panel displays Network Menu Three



Slave CPU 1 is at network addr ?

Figure 36 Network Menu Three

Enter the address for the first slave CPU. Network Menu Three will change to prompt for the address of the next slave CPU until the number of slave processors entered in Network Menu Two are identified.

The panel then displays Network Menu Four.

Use modem [FALSE] ?

Figure 37: Network Menu Four

Enter YES if the master panel is NOT connected to a modem. If a modem is connected to Port B or Port C of the master panel, press CHANGE to alter the statement to TRUE and press ENTER.

The panel displays Network Menu Five.

Share zones [FALSE] ?

Figure 38: Network Menu Five

If necessary, use the CHANGE key to change the selection to [FALSE].

Enter YES.

The panel displays Network Menu Six.

Peer to Peer [FALSE] ?

Figure 39: Network Menu Six

If necessary, use the CHANGE Key to set Peer to Peer to [FALSE] and press YES.

The panel displays the Remote Alarms Query Menu.

Remote Alarms [TRUE] ? [10]

Figure 40: Remote Alarms Query Menu

The setting of Remote Alarms determines whether an alarm condition originating at another panel is annunciated on this LCD display. If necessary, use the CHANGE Key to set Remote Alarms [TRUE] and press YES.

The panel displays Network Menu Seven.

Port B Protocol = 0 ? (Normal = 0)

Figure 41: Network Menu Seven

Port B Protocol should be set to zero.

Press YES.

The panel displays Network Menu Eight.



Figure 42: Network Menu Eight

If necessary, use the CHANGE key to select [GLOBAL] and Press YES.

The panel displays Commission Menu Three.



Figure 43: Commission Menu Three

C.2.b. Slave Panel Programming, Report and Control Network

The slave CPU(s) may be programmed individually using the control keys on each panel to access Commission Menu Three. Use option 3)Network on the Commission Menu Three. If the Master Panel and the slave CPU(s) are set up as outlined in section C.2. with the memory lock switch left in the unlocked position, all programming may be done from the Master Panel. This section outlines that procedure.

Note: After completing slave Panel Programming, run the setup program at each panel, set memory lock check to YES, and lock the memory.

Select Option 4)Talk to Slave from Commission Menu Three.

The Panel queries for the CPU number.



Figure 44: Master-to-Slave Menu One

Note: In messages on the LCD, the panel software will identify the first slave panel as Slave CPU 1, the second slave panel as Slave CPU 2, and so on.

Enter 01 to talk to CPU1.

The panel displays Commission Menu One.

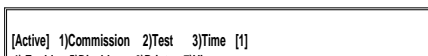

Figure 45: Commission Menu One

Note: CPU1 is now being programmed from the Master Panel. The menu displayed on the Master Panel is Commission Menu One of Slave Panel One (CPU1). The display on both panel displays is identical and programming may be performed from either or both panels.

Select option 1)Commission.

The panel prompts for the password.

Enter the Level Three Pass Code (9898).

Press YES twice to reach Commission Menu Three (on CPU1).

The panel displays Commission Menu Three.



Figure 46: Commission Menu Three

Select option 3)Network.

The Panel displays Network Menu One.

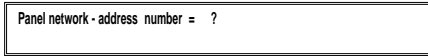

Panel network - address number = ?

Figure 47: Network Menu One

Enter the Network address for CPU1. This is a number from one to 20.

Note: In messages on the LCD, the panel software will identify the first slave panel as Slave CPU 1, the second slave panel as Slave CPU 2, and so on.

Avoid confusion by giving each slave panel the same identifier as the panel software: e.g. assign CPU1 the network address one (1).

Enter a number and press ENTER.

The panel displays Network Menu Two.

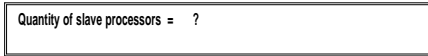

Quantity of slave processors = ?

Figure 48: Network Menu Two

Enter zero and press ENTER. The panel displays Network Menu Four.



Use modem [FALSE] ?

Figure 49: Network Menu Four

Enter YES if CPU1 is NOT connected to a modem. If a modem is connected to Port B or Port C of CPU1, press CHANGE to alter the statement to TRUE and press ENTER.

The panel displays Network Menu Five.



Share zones [FALSE] ?

Figure 50: Network Menu Five

If necessary, use the CHANGE key to change the selection to [FALSE].

Enter YES.

The panel displays Network Menu Six.



Peer to Peer [FALSE] ?

Figure 51: Network Menu Six

If necessary, use the CHANGE Key to set Peer to Peer to [FALSE] and press YES.

The panel displays the Remote Alarms Query Menu.

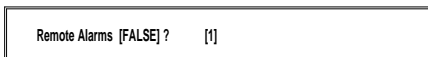

Remote Alarms [FALSE]? [1]

Figure 52: Remote Alarms Query Menu

Set Remote Alarms to [FALSE] on all sub panels.

Enter YES. The panel displays Network Menu Seven.





Port B Protocol = 0 ? (Normal = 0)

Figure 53: Network Menu Seven

The Port B Protocol for the slave panels in a Report and Control network must be set to 0. Press YES.

The panel displays Network Menu Eight.

System events [LOCAL] ?

Figure 54: Network Menu Eight

If necessary, use the CHANGE key to select [LOCAL] and Press YES.

The panel displays Commission Menu Three.

1)Day Modes 2)Setup options 3)Network [1]
4)Talk to Slave

Figure 55: Commission Menu Three

Press NO to return to the Configure Menu.

1)CONFIGURE YES)More Options [1]
2)INSPECT 3)NORMAL OPERATION

Figure 56: Configure Menu

Enter 3)NORMAL OPERATION.

The display shows the Memory Check Message.

Don't forget to lock the memory!
2)INSPECT 3)NORMAL OPERATION

Figure 57: Memory Check Message

If the Master Panel and the slave CPU(s) are set up as outlined in section B.2 press 3)Normal Operation a second time to return to Commission Menu One. Press RESET. This closes the Network process for CPU1 and returns the display returns to Commission Menu Three for the Master Panel.

1)Day Modes 2)Setup options 3)Network [10]
4)Talk to Slave

Figure 58: Commission Menu Three

Repeat the network programming procedure (beginning at Section B.2.b) for each slave panel. After completing network programming for the last slave panel press NO from Commission Menu Three and return to Commission Menu Three for the Master Panel.

Press NO to return to the Configure menu.

Press 3)NORMAL OPERATION to return to the Operator's Menu, Mail Level.

Run the Set Up procedure as described in section C.1. of the Programmer's Guide and set the Memory Lock Check (Section C.1.h.) to [Yes] on the Master Panel and each Slave Panel.

D. Panel Programming Options

Protocol Number	Description	Application
0	Default Network Option	Connection to a Master Panel Connection to a Graphics PC
20	Fire Zone	Pager
21	Fire Zone + Text	Pager
30	PC Interface	Two-way interface with acknowledgment
31	PC Interface	One-way interface

